



Intertek
3073615

AIRREX[®]

AIR CONDITIONER

USER'S MANUAL

MODEL : HSC(O)-14



HSC-14



HSCO-14

- ▶ Thank you for purchasing the unit. Before operation please read this user's manual carefully.
- ▶ Keep this manual on hand for reference.
- ▶ This unit is specified for use on the rated voltage power supply. For use outside the local electricity supply should be checked by a qualified electrician.
- ▶ It is essential that you read 'SAFETY INSTRUCTIONS' carefully before use and follow them at all times.
- ▶ The warranty form is on the last page. Please complete it now and keep it in a safe place.
- ▶ We have a policy of continual improving on our products. The contents (features and specifications) in this manual are therefore subject to change without notice.

TABLE OF CONTENTS

■ SAFETY INSTRUCTIONS	3~4
■ GENERAL ADVICE BEFORE USE	4
■ EXTERIOR DESCRIPTION	5
■ SPECIFICATIONS	6
■ CONTROL PANEL FUNCTIONS	7
■ MODE CHANGING METHOD	8
■ HOW TO SET THE 'OFF' TIMER	9
■ TEMPERATURE CONTROL OPERATION	10
■ SELECTION	11
■ 'ERROR' and WARNING INDICATORS	12
■ FIRE ALARM & ERROR SIGNAL CONNECTION	13
■ ECONOMIC MODE & TROUBLE SHOOTING	14
■ CLEANING AND MAINTENANCE	15
■ ACCESSORIES	16
■ WARRANTY	20

The following instructions are to ensure user's safety and to prevent any physical injury or material damage. Please read carefully and follow all instructions. There are two sections to these instructions: WARNING and CAUTION.

SAFETY INSTRUCTIONS

WARNING

- Use a circuit breaker for the capacity. (It may cause fire and electric shock)
- Before cleaning, disconnect the unit. (Otherwise risk of electric shock)
- Do not use a damaged power cable. (Short, fire or shock hazard)
- Do not use an extension lead unless of the approved type. (Risk of fire and / or electric shock)
- Do not place anything on top of the machine. (This could cause electric shock, malfunction or injury)
- Do not 'kink' or sharply bend the power cable nor put any weight on it. (The insulation may be damaged causing fire or electric shock)
- Turn off control panel after turn off circuit breaker first. (Risk of electric shock and / or malfunction)
- Do not use this unit on unstable or inclined surfaces. Always use on solid flat floor. (Risk of falling causing injury, fire or malfunction)

The following symbols are for your guidance:

= You must NOT. = You MUST.

Keep this manual in a visible location near the unit for easy reference.

INSTALLATION

WARNINGS REGARDING PROPER LOCATION FOR INSTALLATION



WARNING

Do not use the unit in explosive environments or in areas where flammable gas leakage may occur.

Do not use the unit in areas where it will be exposed to rain or water.

Do not use the unit in a corrosive atmosphere.

Do not install the unit on uneven or sloping surface. The unit may roll or topple over even if the casters are set to the locked position.

MOVING THE UNIT

Unlock the casters and push the unit to a flat, level surface and set the caster brakes to the locked position.

PLUGGING IN THE UNIT

Check the prongs and surface of the power cord plug for dust/dirt. If dust and/or dirt are present, wipe off with a clean, dry cloth.

Check the power cord, plug and prongs for damage or excess play.

If any damage or excess play is found, contact a qualified repair technician or a qualified electrician to perform replacement or repair of the power cord, plug or prongs.



WARNING

If the power cord or plug is damaged, repair should only be performed by qualified electrical personnel.



WARNING

Do not connect/disconnect the power cord or attempt to operate buttons with wet hands. This could result in electrical shock.

SAFETY INSTRUCTIONS

CAUTION

- Do not place this unit on uneven, unstable or inclined surface.
(This could cause malfunction)
- When storing this unit, keep it in a dry, cool place.
(To prevent corrosion and malfunction)
- If not being used for some time or if lightening is present, always disconnect from power.
(To prevent risk of electric shock, short circuit or fire)
- Do not spray water onto this unit nor use solvents
such as benzene, thinner or alcohol for cleaning.
(There is a risk of electric shock and / or short circuit)
- Designed for indoor use.

GENERAL ADVICE BEFORE USE

- * Ensure the safety of the location in which the unit is to be used.
- * Ensure the floor or ground is smooth and round.
- * Ensure you allow at least 20 inch air space all around the unit.
- * When in position LOCK the casters to prevent rolling.
- * Never use the unit at more than 2° incline.
- * If you use condensate pump connect with housing in the power box. (Electric panel)
- * You have to connect supply cord at least standard
If the supply cable is damaged, it must be replaced by the manufacturer,
its service agent or similarly qualified person in order to avoid a hazard.

FOR MAXIMUM EFFICIENCY

- * In airtight areas use vertical exhaust into ceiling.
- * If possible locate exhaust outlet through a window or door to outside.
- * Exhaust ducting should be no longer than 6.6 ft. for maximum efficiency.
- * Ensure correct electricity supply.



Waste electrical and electronic products must be disposed separately from normal household waste. When you dispose of such products, please recycle where facilities exist. Follow the guidance of your local authority and/or ask the shop where you purchased the product.

EXTERIOR DESCRIPTION

FRONT VIEW

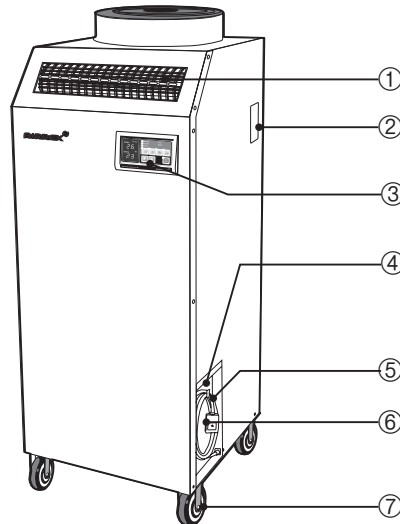
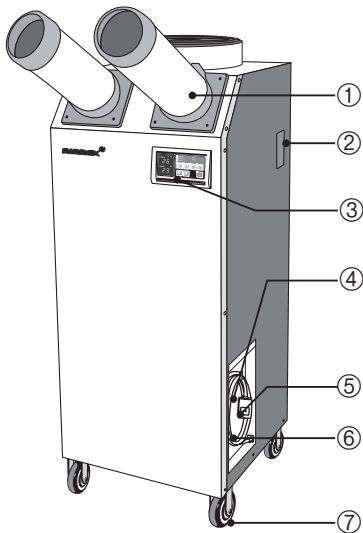

- ① Cool Air Outlet
- ② Handle
- ③ Digital Controller
- ④ Electrical Access panel
- ⑤ Power Plug
- ⑥ Fire Alarm Connection Port
- ⑦ Casters (Front Lockable)

BACK & SIDE VIEW

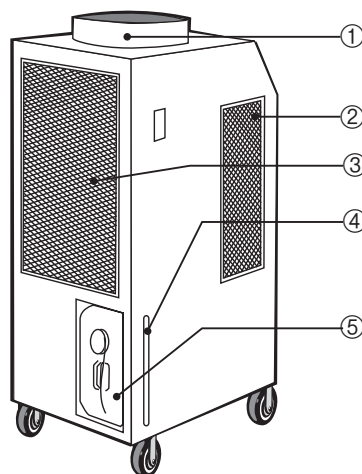
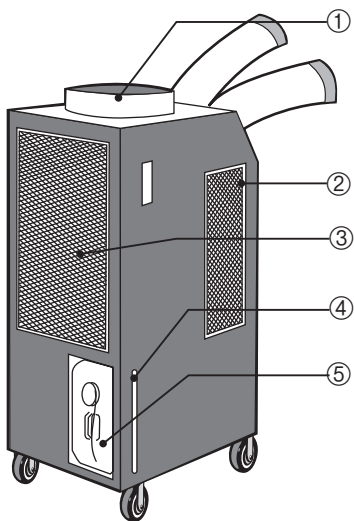

- ① Top Fan / Wiregrille
- ② Evaporator Filter Ambient Air Intake
- ③ Condenser Filter
- ④ Water Level Indicator to Check water Level of the Condensate Tank
- ⑤ Condensed Water Tank to collect water generated during cooling

SPECIFICATIONS

MODEL		HSC(O)-14	
Cooling capacity	Btu/h (W)	13,600 (4,000)	
Power Supply	-	115Vac 60Hz 1Ph	
Power Consumption	kW	1.5	
Current Consumption	A	13	
Moisture Removal	MAX	gal/day	13.3
	AHAM	gal/day	8.9
Refrigerant	lb	R-410A / 1.33	
Dimensions (WxDxH)	inch	19.3 x 23.6 x 46.8	
Weight	lb	176	
Operating Range	Cooling	65 °F DB 60%RH ~ 113 °F DB 40%RH	
	Dehumidifier	59 °F DB 60%RH ~ 113 °F DB 40%RH	
Nema Plug		LCDI 5-15	

※When operating at less than 72°F, the A.F. function can be activated occasionally.(Cooling mode)

CONTROL PANEL FUNCTIONS

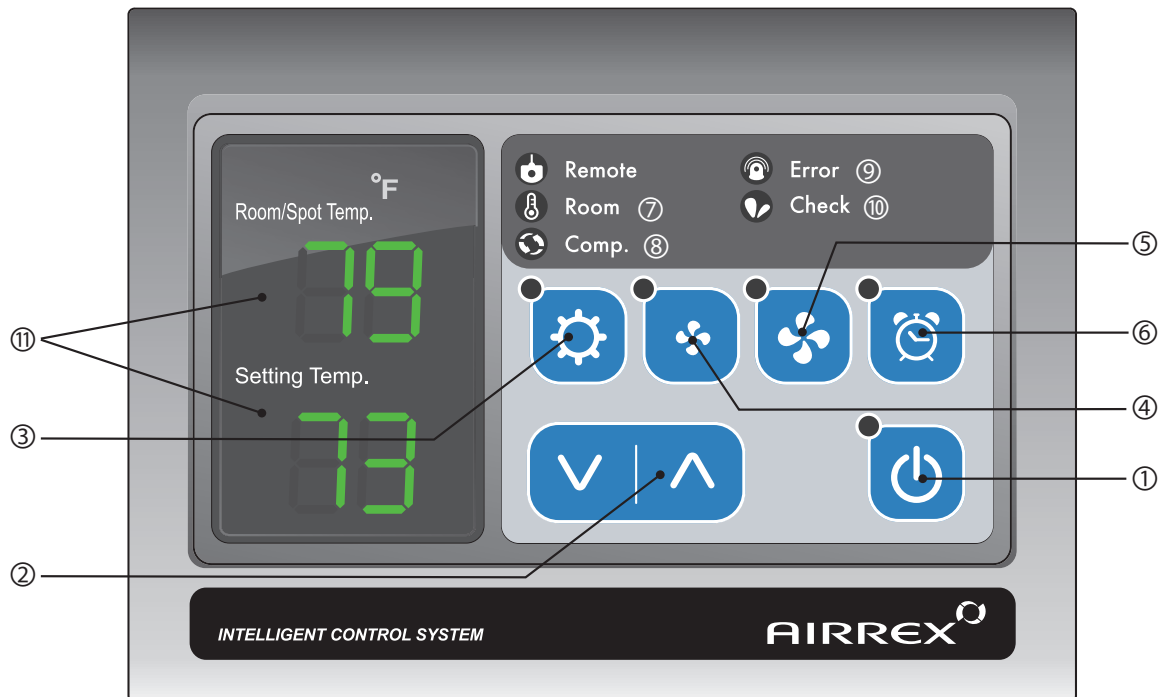

- ① Power : Use to power on / off.
- ② ∨ ^ Button : Raises or lowers the setting temperature or sleep (off) time.
- ③ Mode : Use to select Cooling / Fan / Dehumidifier mode.
- ④ Low Speed : Controls fan low speed.
- ⑤ High Speed : Controls fan high speed.
- ⑥ Off Timer : To set the length of time, once turned on, that you wish the cooler to run for.
You can set 0~24 hours. Time intervals are 30 mins. up to 10 hours and then 1 hour between 10 and 24 hours.
- ⑦ Room : If the LED is on, the displayed temperature is for room temp.
- ⑧ Comp. : When the compressor is operating, the LED is on.
- ⑨ Error : Error signal.
- ⑩ Check : If water full or Aligh Drain Tank is checking. The LED is on.
- ⑪ Display : Display Room temperature, and also the setting temp and sleep time if they had been set.

MODE CHANGING METHOD

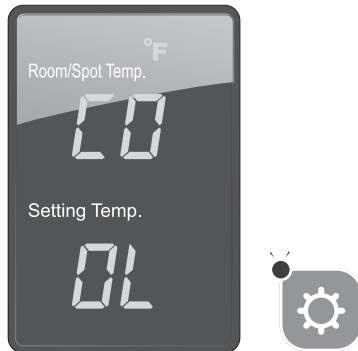

※ COOLING MODE

If you press 'Mode' button, 'COOL' is displayed, then LED is on.

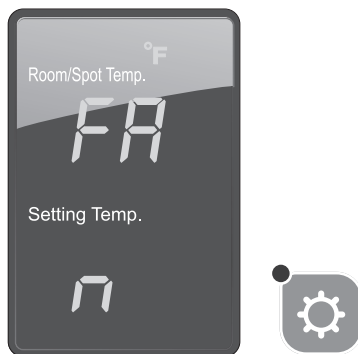

※ FAN MODE

When the cooling is operating. If you press the 'Mode' button, 'FAN' is displayed, then LED is off.

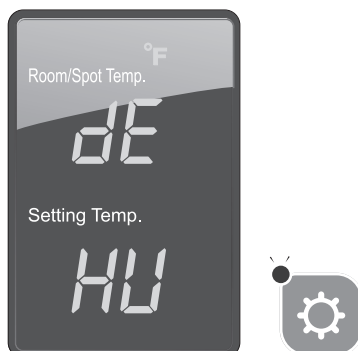

※ DEHUMIDIFICATION MODE

When the fan is operating, If you press the 'Mode' button, 'DEHU' is displayed, then LED is on.

HOW TO SET THE 'OFF' TIMER

This function enables you to set the length of time you want the unit to operate. You can set the time period from 30min. to 24 hours in 30min. and 1 hour increments.

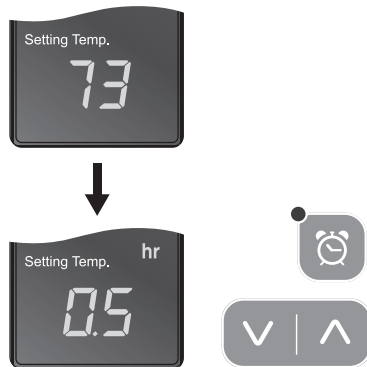

1. When unit is operating, press the 'Off Timer' button and set the length of time you want by pressing \wedge or \vee . Each time you press the button you will increase the 'time to off' period by 30mins. up to 10 hours, and 1 hour up to 24 hours. The display will show 5 for 30min and 1 for an hour. One and a half hours will show 1.5.



OFF TIMER LAMP IS ON

2. When you have finished setting the time period, the 'Off Timer' lamp will be on which indicates the unit is in sleep (Off Timer) mode.



AFTER 1hr

3. If you press the 'Off Timer' button during its operation, the remaining time will be shown.

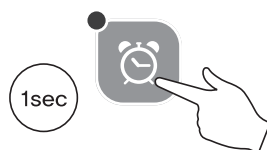

4. To CANCEL timing, press and hold 'Off Timer' button for 1 second. It will then switch the timer off automatically.

TEMPERATURE CONTROL OPERATION

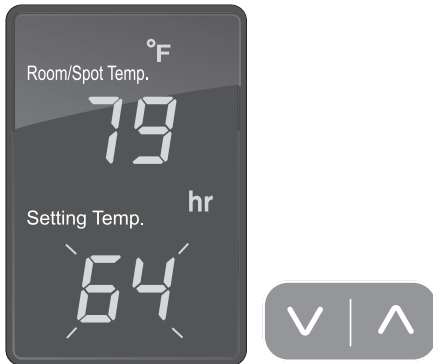

- When you turn ON, the setting temperature is displayed.
- You can change setting temperature.
- The display showing the set temperature will blink 3 times.

Display Room Temperature range & Setting range.

COOLING MODE

Mode	Display range	Setting range
Room	32°F ~ 99°F	64°F ~ 86°F

Cooling operates when Room temperature is more than set temperature.

Cooling stops when Room temperature is less than set temperature.

SELECTION

SPOT or ROOM MODE

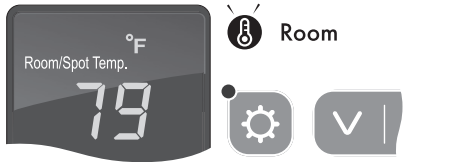

To change the temperature of the entire room, select Spot or Room mode. For 'targeted' cooling of machinery servers or people etc select 'spot mode'. Applicable only when cooling mode.

- If you want to display room temperature, when unit is operated, push 'mode' and 'v' button simultaneously for 3 seconds.
- Light be on the 'Room LED' when room mode set.

LOCK or UNLOCK



- If you press 'v' for 5 seconds when the unit is turned off you can control 'LOCK, UNLOCK' mode.
- When You set 'LOCK' there will be '.' below the number in the screen.

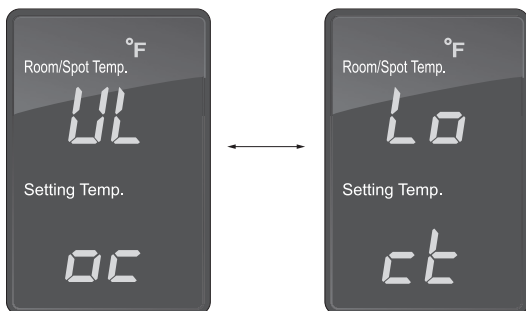





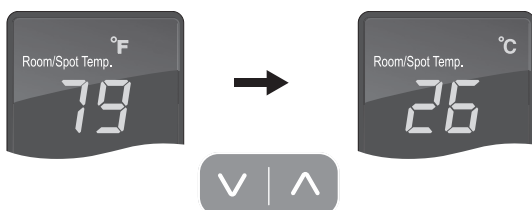





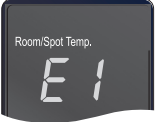

- You can set 'UNLOCK' or 'LOCK' after pressing '^' button.

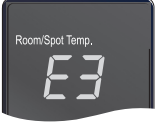
°F or °C

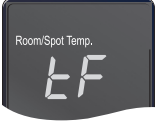

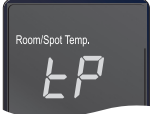
- If you want to change temperature unit °F ↔ °C, when the unit is stopped, push 'v' and '^' button simultaneously for 3 seconds.

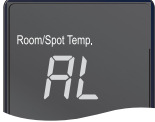
'ERROR' and WARNING INDICATORS

Error Code	Problem	Cause	Corrective Action
  Error 	High pressure	Blocked air filter Blocked / kinked exhaust duct Ambient temperature is too high	Ensure exhaust duct is not blocked / kinked Do not use the air conditioner if ambient temperature is higher than 113°F
  Error 	Low pressure	Verify Electrical Refrigerant may be low	Clean Filters and Coils Verify Power (Voltage/Amps) Check Filters Evaporator/Condenser Check Evaporator/Condenser Coils Check refrigerant level and/or refrigerant leak.
  Error 	Sensor	Temperature sensor has an electric short.	Exchange temperature sensor
  Check 	Water full	Condensate tank is full	Empty the water tank
  Check 	Align water tank	Water tank is not positioned correctly	Place the water tank in right position
  Error 	Fire alarm signal	Fire alarm signal is received from Fire alarm system.	Reset unit by pushing and holding the "OFF TIMER" button for 5 seconds.
	Anti-Freezing alarm	Evaporator is below 25 °F (-4 °C) due to being used in a low ambient temperature area.	Do not use the unit in an ambient temperature less than 72°F (22°C). Check refrigerant level.

FIRE ALARM & ERROR SIGNAL CONNECTION

FIRE ALARM

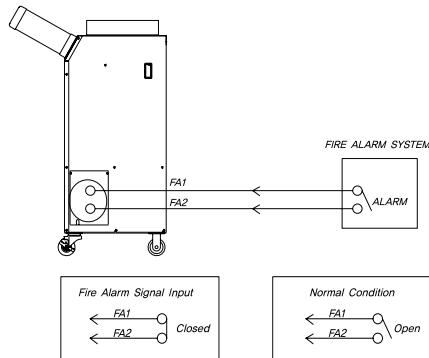

Input Terminal FA1 and FA2

When the signal from the fire alarm system is received, the unit turns off and does not operate until the unit has been RESET.

Connecting the fire alarm wire from fire alarm system

1. Remove 'Cap' and the 'Fire Alarm cover'.
2. Use recommended fire alarm wire size from 16 AWG to 26 AWG for a solid wire, or 16 AWG to 22 AWG for a stranded wire with ring terminal for #5 stud size.
3. Connect fire alarm to terminal FA1 and FA2.

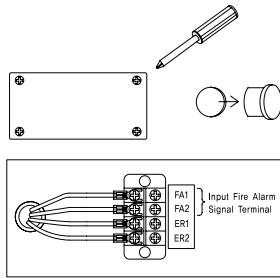

ERROR SIGNAL CONNECTION

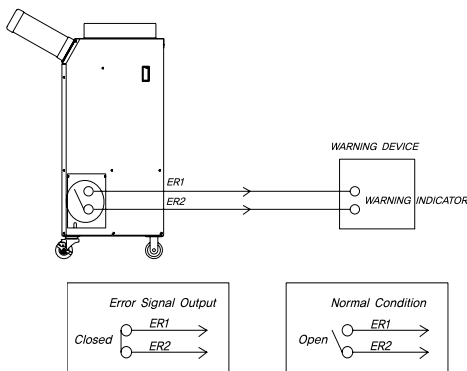

Output Terminal ER1 and ER2

The unit will output an Error signal (normal open dry contact) when an "Error" has occurred, to show what the failure is on the unit.

Connecting Error Signal with warning device

1. Remove 'Cap' and the 'Fire Alarm cover'.
2. Use recommended error signal wire size from 16 AWG to 26 AWG for a solid wire, or 16 AWG to 22 AWG for a stranded wire with ring terminal for #5 stud size.
3. Connect the end of the error signal wire to ER1 and ER2, and the other end to the compatible with various warning devices such as alarm speaker, light indicators, and etc.

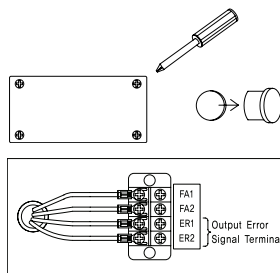

ECONOMIC MODE

Model	Cond. Fan		Evap. Fan		economic mode button (3 sec. continuous)	Etc.
	Economy	Normal	Economy	Normal		
HSC-12L	-	-	Stop after 30 sec.	Run	airflow	Fan integral type
HSC(O)-14/18	Stop	Run	Stop after 30 sec.	Run	airflow (High)	
HSC(O)-24A	Stop	Run	Stop after 30 sec.	Run	airflow (High)	
HWC-19	Stop	Run	Stop after 30 sec.	Run	airflow (High)	
HSC(O)-36B	Stop after 1 min.	Stop after 1 min.	Stop after 1 min.	Run	▲ (UP)	
HSC(O)-60	Stop after 1 min.	Stop after 1 min.	Stop after 1 min.	Run	▲ (UP)	
HSC-70	Stop after 1 min.	Stop after 1 min.	Stop after 1 min.	Run	▲ (UP)	
AHSC-12	Stop	Run	Stop after 30 sec.	Run	airflow	
AHSC-14	Stop	Run	Stop after 30 sec.	Run	airflow	
AHSC-18	Stop	Run	Stop after 30 sec.	Run	airflow	
AHSC-42	Stop	Run	Stop after 30 sec.	Run	▲ (UP)	
AHSC-60	Stop	Run	Stop after 30 sec.	Run	▲ (UP)	
AHSC-140	Stop after 1 min.	Stop after 1 min.	Stop after 1 min.	Run	▲ (UP)	

TROUBLE SHOOTING

TROUBLE	CHECK	REMEDY
NOT WORKING	Power cable correctly connected	Connect cable correctly
	Power button "OFF"	Press POWER button to "ON"
	Fuse (supply) blown	Exchange fuse in board
	Breaker on switch board tripped	Check load capacity and reset
	Ambient temp. too high	Check operating temp. range
POOR COOLING	Filter blocked with dust	Clean Filter
	Dust in heat exchanger	Clean heat exchanger
	Obstacle against inlet side	Remove and allow 20"(50cm). clearance

CLEANING AND MAINTENANCE

CLEANING THE AIR FILTERS

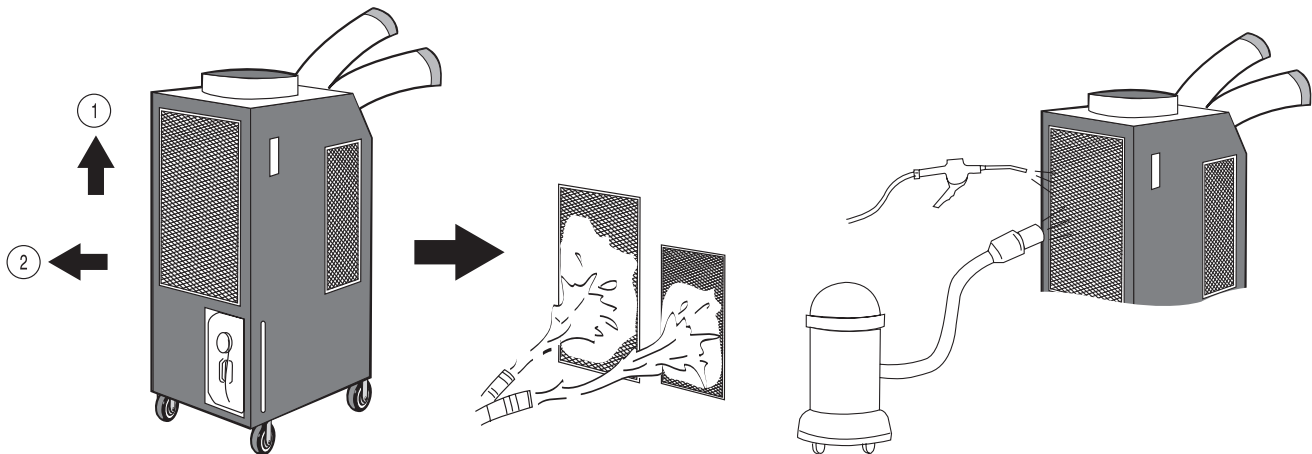

1. To remove filters, slide up a little ① and pull towards you ②.
2. Clean the filters with water or compressed air.
3. Clean evaporator and condenser units with a vacuum cleaner or compressed air.

MAINTENANCE

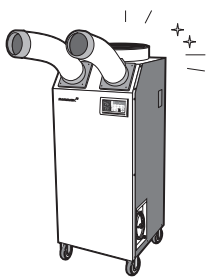

1. After cleaning, completely dry the inside of the unit by operating on 'Fan Mode'.

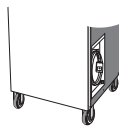

2. Turn "OFF" at control panel, remove plug from socket. Coil and store cable neatly.

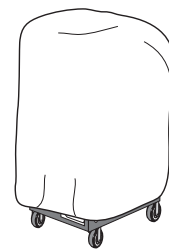

3. Keep machine suitably covered to prevent damage by damp, humidity and dust.

ACCESSORIES

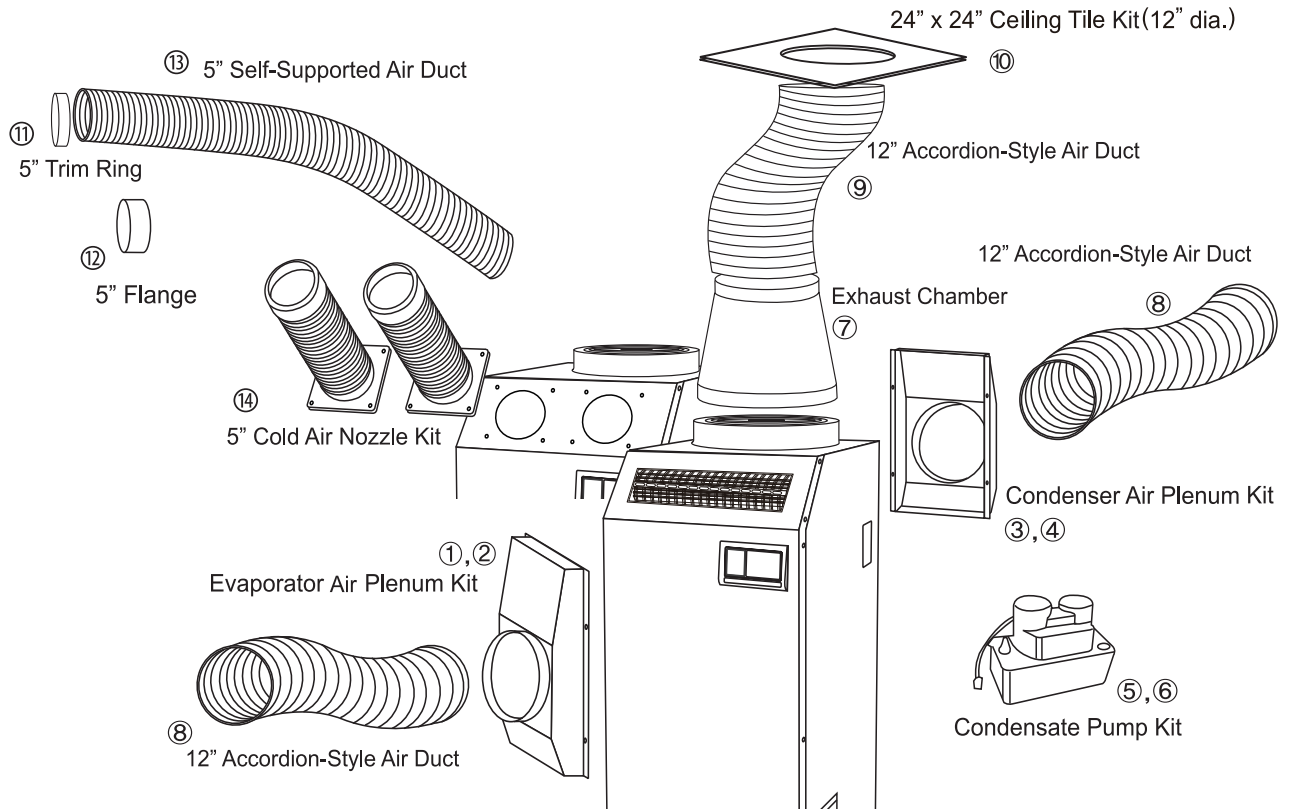

No.	Item Description	Part number	HSC(O)-14	HSC(O)-18	HSC(O)-24A
1	Evaporator Air Plenum Kit	GAC51113	✓		
2	Evaporator Air Plenum Kit	GAC51114		✓	✓
3	Condenser Air Plenum Kit	GAC51115	✓		
4	Condenser Air Plenum Kit	GAC51116		✓	✓
5	Condensate Pump Kit, 115Vac	GAC61110	✓	✓	
6	Condensate Pump Kit, 220Vac	GAC61150			✓
7	Exhaust Chamber	GAC51124			✓
8	12" x 10-ft. Accordion-Style Air Duct	GAC51121	✓	✓	✓
9	12" x 25-ft. Accordion-Style Air Duct	GAC51122	✓	✓	✓
10	24" x 24" Ceiling Tile Kit (12" dia.)	GAC51123	✓	✓	✓
			HSC-14	HSC-18	HSC-24A
11	5" Trim Ring	GAC51120	✓	✓	✓
12	5" Flange	GAC51111	✓	✓	✓
13	5"x10-ft. Self-Supported Cold Air Duct	GAC51112	✓	✓	✓
14	5"x1 ft Cold Air Nozzle Kit	GAC51119	✓	✓	✓

MEMO

WARRANTY

(Applicable to first retail purchaser only)

AIRREX unit gives the more reliable performance, comfort and durability the more they are used. They are built under a strict quality assurance regime which includes inspection both during and after production and exhaustive reliability testing.

In the unlikely event you have any problems, please contact your dealer or distributor. If the problem is as a result of a production fault or failure, repairs will be undertaken free of charge during the period of warranty subject to the following warranty conditions:

1. If the problem has been caused by customer error or misuse, abuse or damage, then all repairs will be charged for.
2. This warranty applies to your country.
3. Proof and date of purchase must be supplied.
4. Please complete the details below and keep this warranty in a safe place.
5. All transportation charges back to the dealer are at customer's cost. Keep all original packaging to facilitate return. Return to customer will be at dealer's cost (if genuine warranty claim).

DESCRIPTION	AIRREX AIR CONDITIONER		
MODEL	HSC(O)-14		
DATE OF PURCHASE		PRODUCT SERIAL NO.	
WARRANTY PERIOD	() Months		
DISTRIBUTOR	Name of Company		
	Telephone No.		
CUSTOMER DETAILS	Name :		
	Address :		
	Telephone :		

Manufactured by :
HEPHZIBAH CO.,LTD.
(Juan-dong) 86, Gilpa-ro
71beon-gil, Michuhol-gu,
Incheon, Korea
TEL : +82-32-509-5834
FAX : +82-32-502-5519
E-mail : airrex@hdtek.com
Website : www.airrex.biz

Distributed by :
Airrex USA
1191 Jewell Dr Ste 101 Waco, TX 76712

TEL : 888-535-8841
FAX : 469-574-7924
E-mail : sales@airrexusa.com
Website : www.airrexusa.com